

Display Fixture

陳列架五金

CATALOG 2025

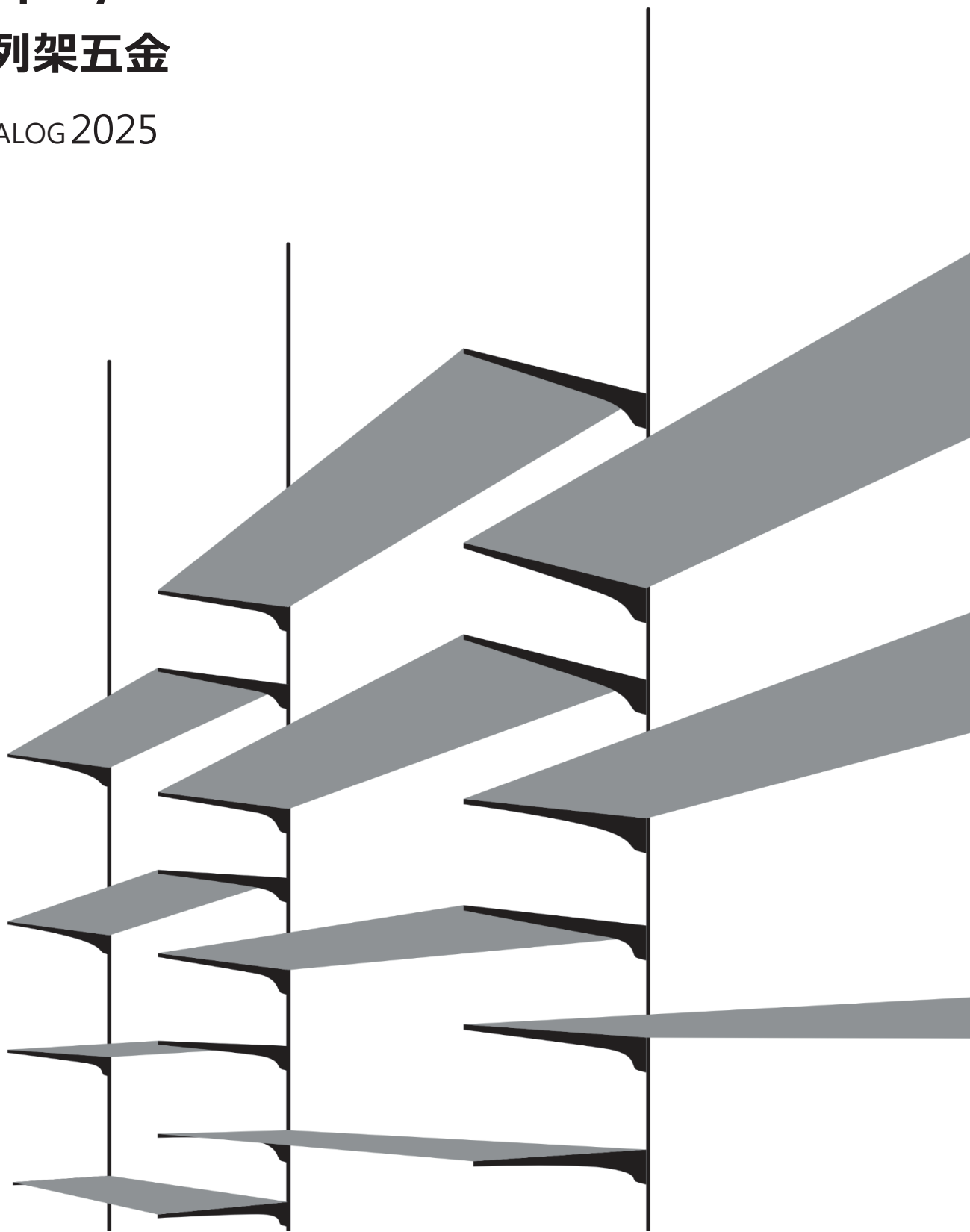

2025/3/1起適用
v3



重柱 Slit rail

單排D series

KAWAJUN



價格表 PRICE



D17

型號	尺寸(mm)	鍍鉻	黑胚	沙丁鏢	黑/白烤漆
MJRD1706	600	\$528	\$386	\$559	\$413
MJRD1709	900	\$771	\$551	\$783	\$582
MJRD1712	1200	\$1,011	\$715	\$1,020	\$771
MJRD1715	1500	\$1,264	\$888	\$1,271	\$945
MJRD1718	1820	\$1,511	\$1,059	\$1,508	\$1,145
MJRD1724	2400	\$2,040	\$1,413	\$2,154	\$1,662
MJRD1730	3000	沒有	\$1,844	沒有	\$2,035

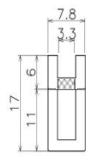

D20

型號	尺寸(mm)	鍍鉻	黑胚	沙丁鏢	黑/白烤漆
MJRD2006	600	\$570	\$412	\$561	\$444
MJRD2009	900	\$826	\$596	\$874	\$631
MJRD2012	1200	\$1,085	\$755	\$1,149	\$813
MJRD2015	1500	\$1,345	\$942	\$1,410	\$1,015
MJRD2018	1820	\$1,631	\$1,131	\$1,685	\$1,292
MJRD2024	2400	\$2,197	\$1,597	\$2,213	\$1,846
MJRD2030	3000	沒有	\$1,936	沒有	\$2,244

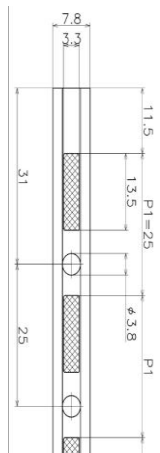
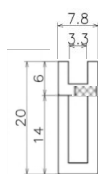

施工範例

固定方式①金屬固定支柱

固定方式②木支柱

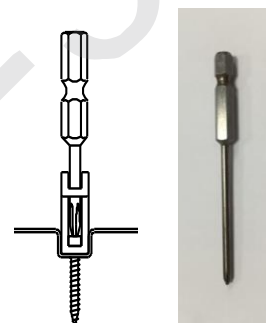
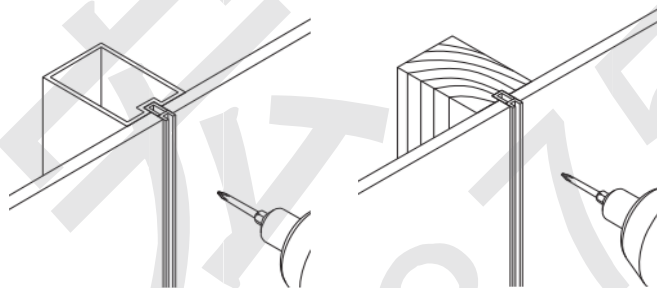

φ3mm(以下)

適用螺絲規格 (另售)

木支柱用: 十字尖頭螺絲 (15/30長)

型號	50入/包
MJNB0215-S	\$211
MJNB0230-S	\$243

金屬用: 十字自攻螺絲φ2.8 (20長)

型號	50入/包
MJNA0220-S	\$258



需使用專用起子頭固定螺絲
六角起子頭φ3

型號	支/單價
MJOP009-2	\$215

產品特色

兩邊高出3.75mm 可隱藏架手掛齒及重柱排孔。

*請注意: D系列重柱無法使用架手固定塞, 由下往上敲架手是會掉落的。

*需搭配專用螺絲以及十字起子頭

重柱 Slit rail

單排S/雙排W series

KAWAJUN



價格表 PRICE

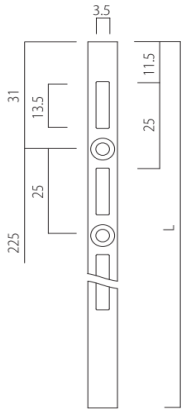
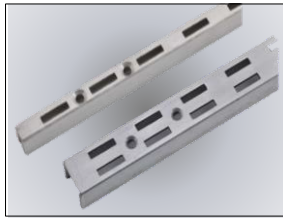

單排 S11

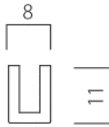

型號	尺寸(mm)	鍍鉻	黑胚	沙丁鏢	黑/白烤漆
MJRS1106	600	\$270	\$187	\$305	\$233
MJRS1109	900	\$382	\$277	\$457	\$334
MJRS1112	1200	\$525	\$356	\$589	\$440
MJRS1115	1500	\$593	\$471	\$695	\$527
MJRS1118	1820	\$699	\$525	\$851	\$622
MJRS1124	2400	\$967	\$692	\$1,188	\$918
MJRS1130	3000	沒有	\$927	沒有	\$1,154

單排 S14

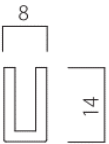

型號	尺寸(mm)	鍍鉻	黑胚	沙丁鏢	黑/白烤漆
MJRS1406	600	\$310	\$215	\$329	\$268
MJRS1409	900	\$413	\$305	\$516	\$360
MJRS1412	1200	\$538	\$385	\$642	\$468
MJRS1415	1500	\$633	\$516	\$776	\$569
MJRS1418	1820	\$758	\$677	\$923	\$673
MJRS1424	2400	\$1,053	\$882	\$1,190	\$921
MJRS1430	3000	沒有	\$1,079	沒有	\$1,253

雙排 W11

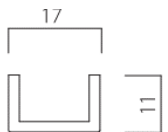

型號	尺寸(mm)	鍍鉻	黑胚	沙丁鏢	黑/白烤漆
MJRW1106	600	\$297	\$226	\$347	\$268
MJRW1109	900	\$429	\$316	\$514	\$367
MJRW1112	1200	\$552	\$429	\$666	\$512
MJRW1115	1500	\$668	\$523	\$804	\$613
MJRW1118	1820	\$818	\$633	\$991	\$734
MJRW1124	2400	\$1,073	\$822	\$1,301	\$1,064
MJRW1130	3000	沒有	\$1,095	沒有	\$1,237

雙排 W14

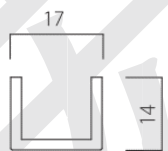

型號	尺寸(mm)	鍍鉻	黑胚	沙丁鏢	黑/白烤漆
MJRW1406	600	\$310	\$237	\$369	\$279
MJRW1409	900	\$448	\$376	\$541	\$396
MJRW1412	1200	\$563	\$485	\$686	\$532
MJRW1415	1500	\$703	\$592	\$853	\$646
MJRW1418	1820	\$848	\$712	\$1,022	\$760
MJRW1424	2400	\$1,112	\$940	\$1,341	\$1,096
MJRW1430	3000	沒有	\$1,174	沒有	\$1,352

施工範例

①金屬固定支柱

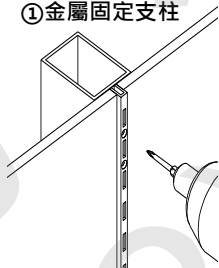

②木支柱

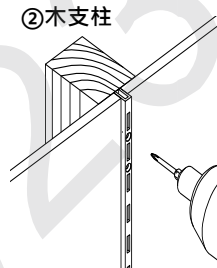

適用螺絲規格
(另售)

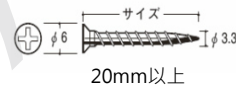

我有販售專用木螺絲(20/25/30mm長)

關聯配件 PARTS

排孔管/重柱用



黑色彈性橡膠圈具止滑功用。



暗樁

型號	鍍鉻	黑色
MJDD12A	\$69	\$65

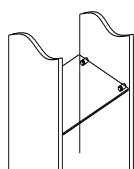

玻璃層板

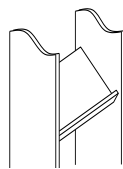

固定方式

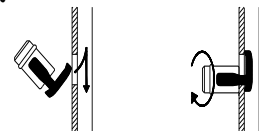

由下往上插入排孔內,順時針方向轉緊固定。

木層板

排孔管 Slit post

38φ圓排孔管

MJRP38 series

KAWAJUN



價格表 PRICE

剖面圖



型號	尺寸(mm)	鍍鉻	黑胚	沙丁鍊	黑/白烤漆
MJRP38S113	1350	\$529	\$468	\$632	\$581
MJRP38S115	1500	\$590	\$525	\$698	\$638
MJRP38S118	1800	\$700	\$624	\$832	\$751
MJRP38S127	2750	沒有	\$968	沒有	\$1,162
MJRP38S135	3500	沒有	\$1,228	沒有	\$1,460

剖面圖



型號	尺寸(mm)	鍍鉻	黑胚	沙丁鍊	黑/白烤漆
MJRP38S213	1350	\$552	\$468	\$653	\$581
MJRP38S215	1500	\$616	\$525	\$734	\$638
MJRP38S218	1800	\$723	\$624	\$861	\$751
MJRP38S227	2750	沒有	\$968	沒有	\$1,162
MJRP38S235	3500	沒有	\$1,228	沒有	\$1,460

剖面圖



型號	尺寸(mm)	鍍鉻	黑胚	沙丁鍊	黑/白烤漆
MJRP38W113	1350	\$566	\$468	\$673	\$581
MJRP38W115	1500	\$633	\$525	\$752	\$638
MJRP38W118	1800	\$740	\$624	\$880	\$751
MJRP38W127	2750	沒有	\$968	沒有	\$1,162
MJRP38W135	3500	沒有	\$1,228	沒有	\$1,460

剖面圖



型號	尺寸(mm)	鍍鉻	黑胚	沙丁鍊	黑/白烤漆
MJRP38W213	1350	\$552	\$468	\$653	\$581
MJRP38W215	1500	\$616	\$525	\$734	\$638
MJRP38W218	1800	\$723	\$624	\$861	\$751
MJRP38W227	2750	沒有	\$968	沒有	\$1,162
MJRP38W235	3500	沒有	\$1,228	沒有	\$1,460

*請注意: 如購買雙排孔架手安裝上會是呈現放射狀的。

施工範例

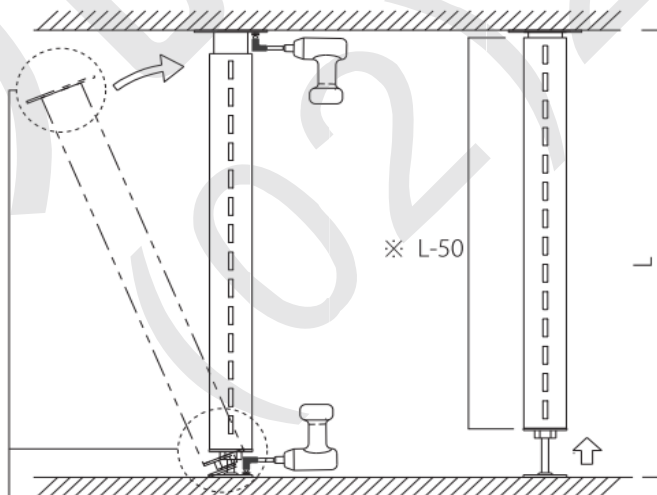

關聯配件



頂天立地 / 調整腳座



調整腳座隱藏套

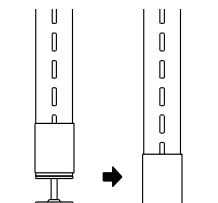

排孔管 Slit post

方排孔管25*25 MJRP2525 series

KAWAJUN

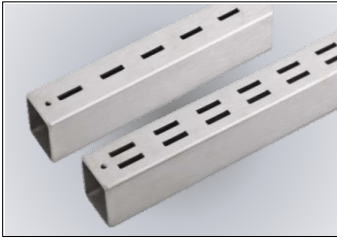

剖面圖



S1

價格表 PRICE

型號	尺寸(mm)	鍍鉻	黑胚	沙丁鍊	黑/白烤漆
MJRP2525S113	1350	\$565	\$406	\$707	\$443
MJRP2525S115	1500	\$659	\$464	\$828	\$542
MJRP2525S118	1800	\$844	\$551	\$977	\$643
MJRP2525S127	2750	沒有	\$730	沒有	\$954



剖面圖



S2

型號	尺寸(mm)	鍍鉻	黑胚	沙丁鍊	黑/白烤漆
MJRP2525S213	1350	\$713	\$412	\$767	\$571
MJRP2525S215	1500	\$779	\$472	\$877	\$633
MJRP2525S218	1800	\$941	\$562	\$1,018	\$672
MJRP2525S227	2750	沒有	\$840	沒有	\$1,062

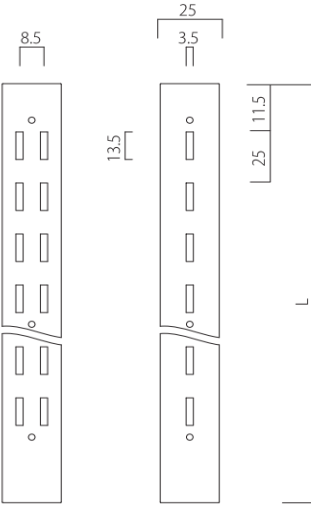

剖面圖



W1

型號	尺寸(mm)	鍍鉻	黑胚	沙丁鍊	黑/白烤漆
MJRP2525W113	1350	\$565	\$406	\$707	\$450
MJRP2525W115	1500	\$659	\$464	\$828	\$542
MJRP2525W118	1800	\$869	\$551	\$985	\$643
MJRP2525W127	2750	沒有	\$762	沒有	\$1,067

剖面圖



W2

型號	尺寸(mm)	鍍鉻	黑胚	沙丁鍊	黑/白烤漆
MJRP2525W213	1350	\$697	\$490	\$767	\$536
MJRP2525W215	1500	\$779	\$510	\$877	\$633
MJRP2525W218	1800	\$941	\$623	\$1,065	\$672
MJRP2525W227	2750	沒有	\$892	沒有	\$1,195

施工範例

關聯配件

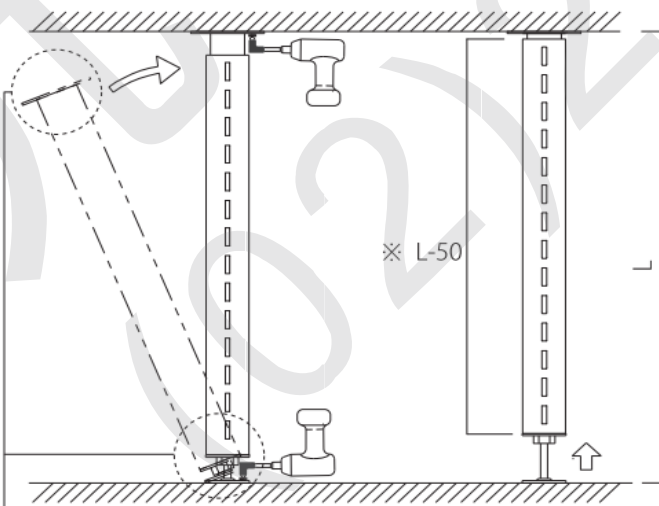

頂天立地 / 調整腳座



調整腳座隱藏套

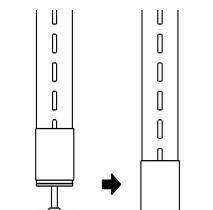

排孔管 Slit post

方排孔管25*40 MJRP2540 series

KAWAJUN

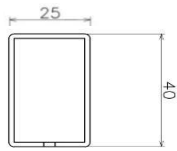

剖面圖



S1

剖面圖



S2

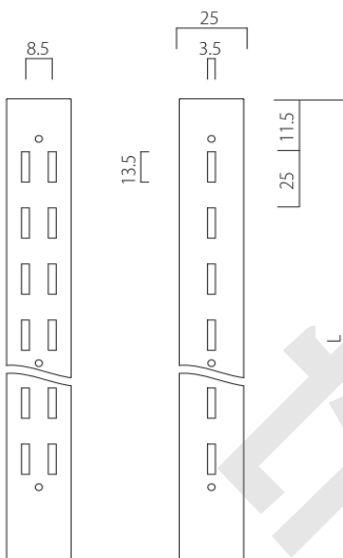

剖面圖



W1

剖面圖



W2



價格表 PRICE

型號	尺寸(mm)	鍍鉻	黑胚	沙丁鍊	黑/白烤漆
MJRP2540S113	1350	\$878	\$611	\$806	\$700
MJRP2540S115	1500	\$977	\$683	\$896	\$780
MJRP2540S118	1800	\$1,153	\$804	\$1,076	\$921
MJRP2540S127	2750	沒有	\$1,223	沒有	\$1,460
MJRP2540S135	3500	沒有	\$1,577	沒有	\$1,859

型號	尺寸(mm)	鍍鉻	黑胚	沙丁鍊	黑/白烤漆
MJRP2540S213	1350	\$981	\$677	\$921	\$801
MJRP2540S215	1500	\$1,090	\$756	\$1,021	\$879
MJRP2540S218	1800	\$1,277	\$889	\$1,229	\$1,040
MJRP2540S227	2750	沒有	\$1,354	沒有	\$1,659
MJRP2540S235	3500	沒有	\$1,742	沒有	\$2,119

型號	尺寸(mm)	鍍鉻	黑胚	沙丁鍊	黑/白烤漆
MJRP2540W113	1350	\$869	\$869	\$806	\$700
MJRP2540W115	1500	\$977	\$683	\$910	\$780
MJRP2540W118	1800	\$1,153	\$804	\$1,095	\$921
MJRP2540W127	2750	沒有	\$1,223	沒有	\$1,460
MJRP2540W135	3500	沒有	\$1,577	沒有	\$1,859

型號	尺寸(mm)	鍍鉻	黑胚	沙丁鍊	黑/白烤漆
MJRP2540W213	1350	沒有	\$677	沒有	\$801
MJRP2540W215	1500	\$1,090	\$756	\$1,077	\$879
MJRP2540W218	1800	\$1,277	\$889	\$1,300	\$1,040
MJRP2540W227	2750	沒有	\$1,354	沒有	\$1,659
MJRP2540W235	3500	沒有	\$1,742	沒有	\$2,119

施工範例

關聯配件

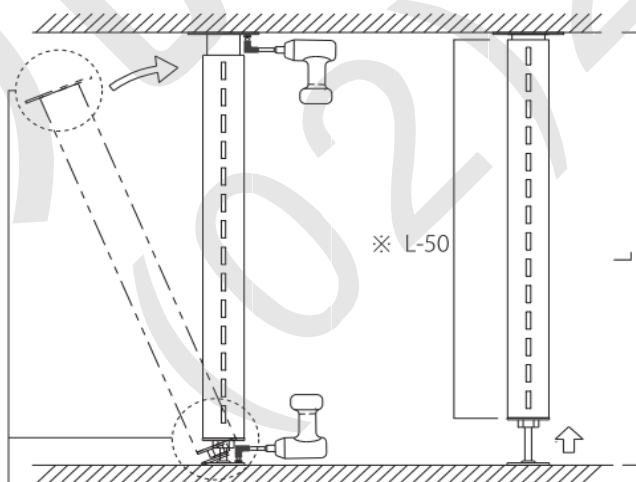

頂天立地 / 調整腳座

排孔管 Slit post

方排孔管40*40

MJRP4040 series

KAWAJUN

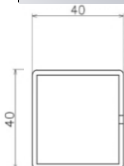
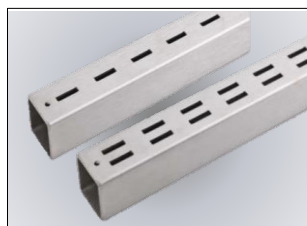

剖面圖



S1

剖面圖



S2



價格表 PRICE

型號	尺寸(mm)	鍍鉻	黑胚	沙丁鍊	黑/白烤漆
MJRP4040S113	1350	\$758	\$646	\$901	\$771
MJRP4040S115	1500	\$837	\$715	\$996	\$844
MJRP4040S118	1800	\$986	\$861	\$1,170	\$1,012
MJRP4040S127	2750	沒有	\$1,317	沒有	\$1,538
MJRP4040S135	3500	沒有	\$1,681	沒有	\$1,948

型號	尺寸(mm)	鍍鉻	黑胚	沙丁鍊	黑/白烤漆
MJRP4040S213	1350	\$771	\$646	\$918	\$771
MJRP4040S215	1500	\$854	\$715	\$1,013	\$844
MJRP4040S218	1800	\$1,007	\$861	\$863	\$1,012
MJRP4040S227	2750	沒有	\$1,317	沒有	\$1,538
MJRP4040S235	3500	沒有	\$1,681	沒有	\$1,948

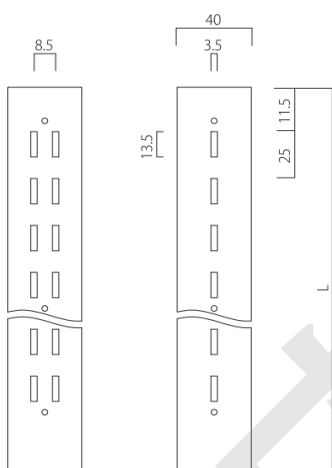

剖面圖



W1

剖面圖



W2

型號	尺寸(mm)	鍍鉻	黑胚	沙丁鍊	黑/白烤漆
MJRP4040W113	1350	\$811	\$646	\$963	\$771
MJRP4040W115	1500	\$892	\$715	\$1,057	\$844
MJRP4040W118	1800	\$1,037	\$861	\$1,234	\$1,012
MJRP4040W127	2750	沒有	\$1,317	沒有	\$1,538
MJRP4040W135	3500	沒有	\$1,681	沒有	\$1,948

型號	尺寸(mm)	鍍鉻	黑胚	沙丁鍊	黑/白烤漆
MJRP4040W213	1350	\$824	\$646	\$982	\$771
MJRP4040W215	1500	\$906	\$715	\$1,078	\$844
MJRP4040W218	1800	\$1,061	\$861	\$1,261	\$1,012
MJRP4040W227	2750	沒有	\$1,317	沒有	\$1,538
MJRP4040W235	3500	沒有	\$1,681	沒有	\$1,948

施工範例

關聯配件

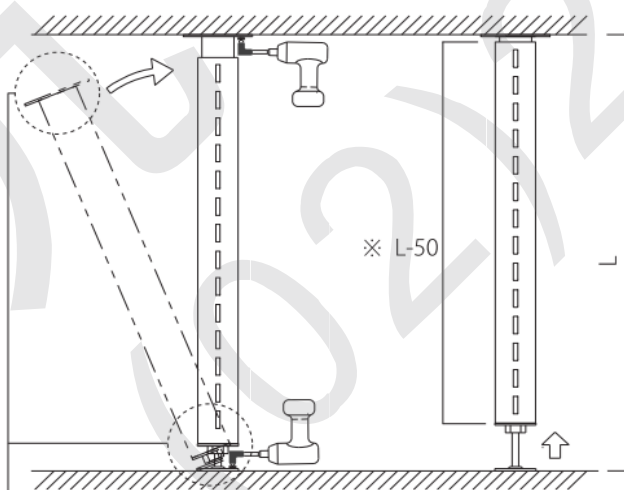

頂天立地 / 調整腳座



調整腳座隱藏套

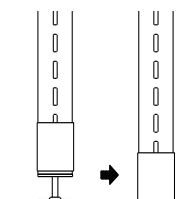

調整腳座 Ajuster

(排孔管)頂天立地/隱藏套

KAWAJUN



價格表 PRICE

方排孔管用

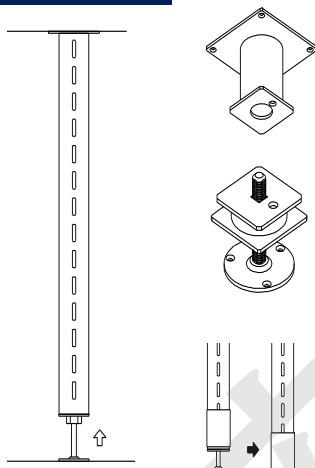

頂天

型號	配合管徑	鍍鉻
MJAG2525	2525	\$311
MJAG2540	2540	\$321
MJAG4040	4040	\$330

立地

型號	配合管徑	鍍鉻
MJAD2525	2525	\$489
MJAD2540	2540	\$523
MJAD4040	4040	\$517

隱藏套

型號	配合管徑	鍍鉻
MJAC2525	2525	\$241
MJAC4040	4040	\$254

圓排孔管用

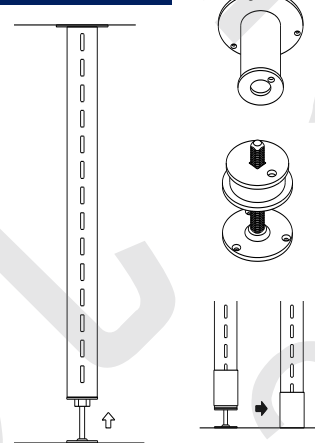

頂天

型號	配合管徑	鍍鉻
MJAG38	φ38	\$332

立地

型號	配合管徑	鍍鉻
MJAD38	φ38	\$469

隱藏套

型號	配合管徑	鍍鉻
MJAC38	φ38	\$220

施工注意事項

※ Please install to the ceiling and floor that have sufficient strength.

請在堅硬的天花板和地面上安裝

※ Install perpendicular to the ground.

請注意垂直於地面之後再安裝

※ Please noted that the length of Slit Post is cut to the actual height (L) minus 25mm ~ 50mm when installing.

安裝時請注意將排孔管尺寸切割為實際高度尺寸減去2.5~5公分

架手 Bracket

玻璃層板用

MJB Series

KAWAJUN

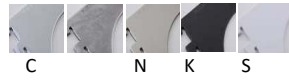

玻璃層板用架手

價格表 PRICE

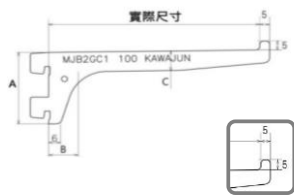

2齒

型號	實際尺寸	鍍鉻	黑胚	沙丁鍊	黑/白	A	B	C
MJB2GC120	207mm	\$130	\$78	\$211	\$86	44.5	20	18
MJB2GC125	257mm	\$147	\$83	\$227	\$95	44.5	25	20



3齒

型號	實際尺寸	鍍鉻	黑胚	沙丁鍊	黑/白	A	B	C
MJB3GC130	307mm	\$224	\$128	\$292	\$138	67	30	26
MJB3GC135	357mm	\$246	\$136	\$308	\$153	67	30	26
MJB3GC140	407mm	\$300	\$149	\$344	\$170	70	35	26
MJB3GC145	457mm	\$323	\$172	\$341	\$198	70	35	26

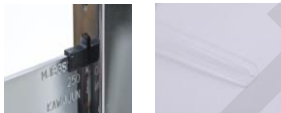

※附架手固定螺絲 ※附透明止滑條



固定塞安裝方式

施工範例

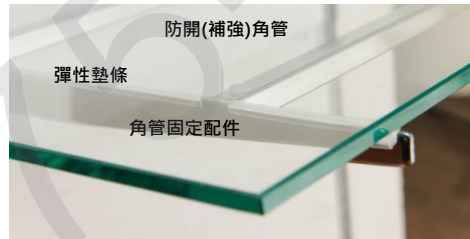
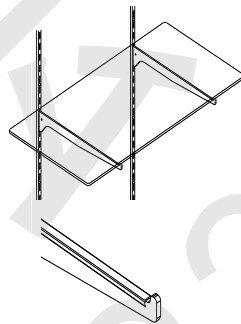

使用玻璃層板架手，建議搭配角管可避免架手左右搖晃，同時增加整體強度。

無1212角管時，請將架手固定於玻璃層板內側。

內縮安全範圍參考距離請參照下表。

玻璃架手建議安裝位置 * 未使用1212角管(橫桿)時								
規格	100	150	200	250	300	350	400	450
安全範圍	25	35	35	40	50	55	100	130

(單位:mm)

關聯配件 PARTS

角管固定配件

1212角管



型號	SUS430
MJBH12	\$11

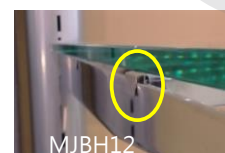

MJBH12

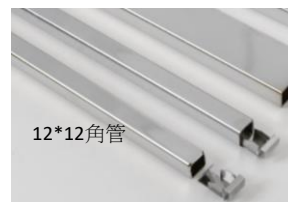

12*12角管



MJBH12

搭配MJBH12配件,裝置於玻璃層板下方,防開補強用。

型號	實際總長	鍍鉻	黑胚	沙丁鍊
MJPH1212596	596	\$164	\$107	\$186
MJPH1212896	896	\$231	\$143	\$266
MJPH12121200	1200	\$280	\$179	\$330

架手 Bracket

木層板用

MJB Series

KAWAJUN

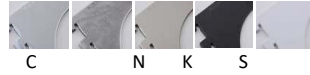

木層板用架手

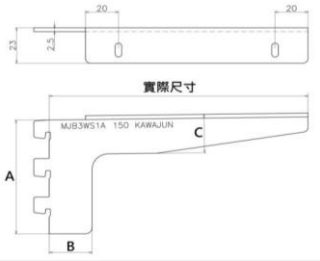

3齒
(右)

價格表 PRICE

型號	實際尺寸	鍍鉻	黑胚	沙丁鍊	黑/白	A	B	C
MJB3WS1A15	157mm	\$141	\$83	\$235	\$102	74	26	25
MJB3WS1A20	207mm	\$160	\$95	\$237	\$114	74	26	25
MJB3WS1A25	257mm	\$192	\$115	\$246	\$137	74	26	25
MJB3WS1A30	307mm	\$239	\$138	\$300	\$177	74	29	29
MJB3WS1A35	357mm	\$305	\$162	\$338	\$194	74	29	29

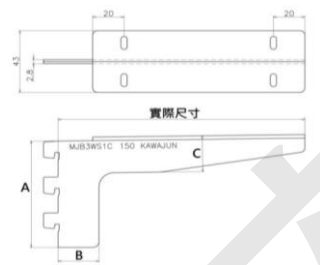

3齒
(左)

型號	實際尺寸	鍍鉻	黑胚	沙丁鍊	黑/白	A	B	C
MJB3WS1B15	157mm	\$141	\$83	\$235	\$102	74	26	25
MJB3WS1B20	207mm	\$160	\$95	\$237	\$114	74	26	25
MJB3WS1B25	257mm	\$192	\$115	\$246	\$137	74	26	25
MJB3WS1B30	307mm	\$239	\$138	\$300	\$177	74	29	29
MJB3WS1B35	357mm	\$305	\$162	\$338	\$194	74	29	29



※附架手固定塞

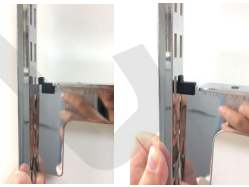

固定塞安裝方式

施工範例

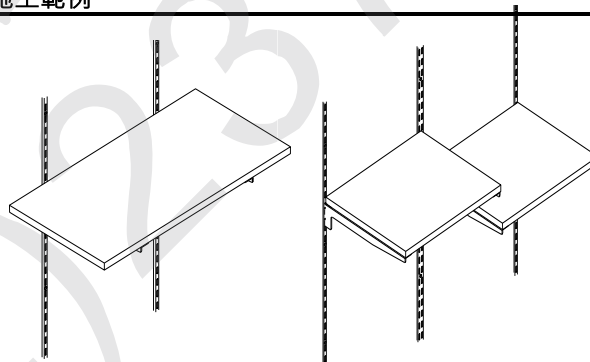

關聯配件 PARTS

木板架手用



樹脂固定扣

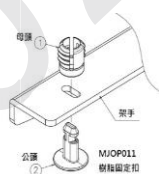

固定扣安裝方式



將固定扣的公頭穿過架手上的
的孔，並組上母頭。



於板材上的對應位置上開洞，
並與固定扣相組合。
建議開孔尺寸φ10 x 深12mm



完成!

型號	單價
MJOP011	\$8

※優勢特色 無需電鑽工具和釘子即可輕鬆裝卸木層板

架手 Bracket

圓管用(φ25/φ32)

MJB Series

KAWAJUN



圓管用架手

價格表 PRICE

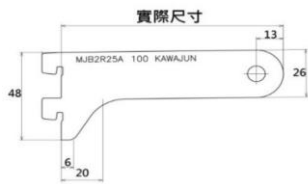

φ25

2齒	型號	實際尺寸	鍍鉻	黑胚	沙丁鏢	黑/白
(右)	MJB2R25A20	207mm	\$166	\$100	\$226	\$114
(左)	MJB2R25B20	207mm	\$166	\$100	\$226	\$114

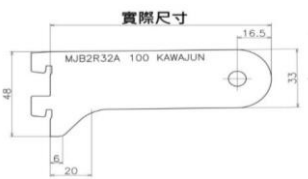

φ32

2齒	型號	實際尺寸	鍍鉻	黑胚	沙丁鏢	黑/白
(右)	MJB2R32A20	207mm	\$166	\$110	\$234	\$120
(左)	MJB2R32B20	207mm	\$166	\$110	\$234	\$120

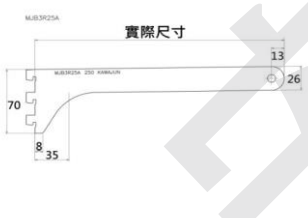

3齒	型號	實際尺寸	鍍鉻	黑胚	沙丁鏢	黑/白
(右)	MJB3R25A25	257mm	\$189	\$120	\$265	\$135
	MJB3R25A30	307mm	\$228	\$143	\$286	\$158
	MJB3R25A35	357mm	\$246	\$144	\$298	\$174
(左)	MJB3R25B25	257mm	\$189	\$120	\$265	\$135
	MJB3R25B30	307mm	\$228	\$143	\$286	\$158
	MJB3R25B35	357mm	\$246	\$144	\$298	\$174



3齒	型號	實際尺寸	鍍鉻	黑胚	沙丁鏢	黑/白
(右)	MJB3R32A25	257mm	\$208	\$138	\$263	\$158
	MJB3R32A30	307mm	\$241	\$154	\$296	\$174
	MJB3R32A35	357mm	\$256	\$159	\$310	\$186
(左)	MJB3R32B25	257mm	\$208	\$138	\$263	\$158
	MJB3R32B30	307mm	\$241	\$154	\$296	\$174
	MJB3R32B35	357mm	\$256	\$159	\$310	\$186



※附架手固定塞

施工範例

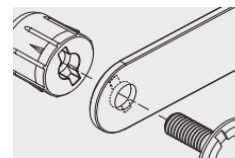
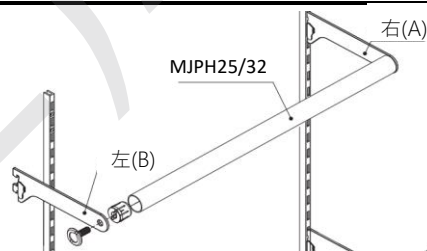

*(B) 突起面朝內固定



*管塞可用膠槌敲入

關聯配件 PARTS

圓管掛桿



有φ25、φ32各種長度, 詳細請參閱型錄④-1

圓管固定配件

*必要配件



圓管用內塞



圓管端頭鎖

架手 Bracket

圓管中央用(φ25/φ32)

KAWAJUN



圓管用架手(中央用)

價格表 PRICE

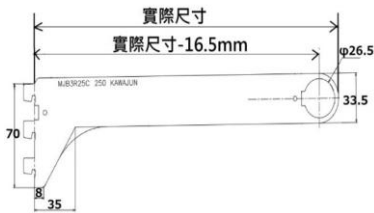

3齒	型號	實際尺寸	鍍鉻	黑胚	沙丁鍊	黑/白
(中)	MJB3R25C25	260.5mm	\$254	\$155	\$256	\$179
φ25	MJB3R25C30	310.5mm	\$268	\$177	\$271	\$204

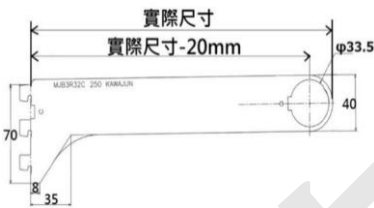

3齒	型號	實際尺寸	鍍鉻	黑胚	沙丁鍊	黑/白
(中)	MJB3R32C25	260.5mm	\$254	\$162	\$256	\$162
φ32	MJB3R32C30	310.5mm	\$268	\$177	\$271	\$204

施工範例

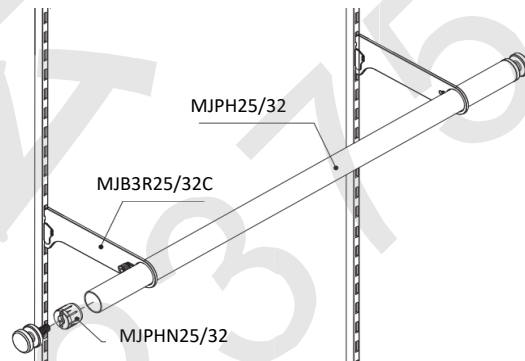

圓管中央貫穿用配件

防脫螺絲



型號	鍍鉻
MJOP010	\$17



使用於圓管架手(中央)系列,可固定貫穿圓管防止滑動,亦可固定於重柱排孔處,防止左右搖晃。

關聯配件 PARTS

圓管掛桿



有φ25、φ32各種長度/顏色,詳細請參閱型錄④-1

圓管固定配件 *必要配件



圓管用內塞



圓管端頭鎖

架手 Bracket

1432角管用

MJB Series

KAWAJUN

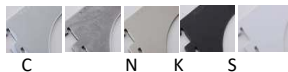

角管用架手

價格表 PRICE

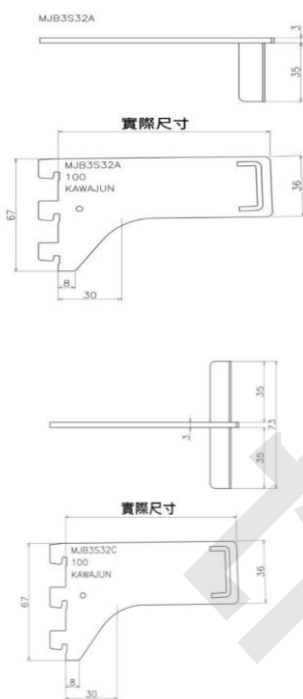

3齒
(右)

型號	實際尺寸	鍍鉻	黑胚	沙丁鏢	黑/白
MJB3S32A05	50mm	\$149	\$97	\$210	\$116
MJB3S32A10	100mm	\$163	\$104	\$243	\$127
MJB3S32A15	150mm	\$203	\$123	\$266	\$147
MJB3S32A20	200mm	\$223	\$141	\$302	\$159
MJB3S32A25	250mm	\$249	\$159	\$329	\$182
MJB3S32A30	300mm	\$300	\$179	\$353	\$211
MJB3S32A35	350mm	\$321	\$197	\$389	\$236

3齒
(左)

型號	實際尺寸	鍍鉻	黑胚	沙丁鏢	黑/白
MJB3S32B05	50mm	\$149	\$97	\$210	\$116
MJB3S32B10	100mm	\$163	\$104	\$243	\$127
MJB3S32B15	150mm	\$203	\$123	\$266	\$147
MJB3S32B20	200mm	\$223	\$141	\$302	\$159
MJB3S32B25	250mm	\$249	\$159	\$329	\$182
MJB3S32B30	300mm	\$300	\$179	\$353	\$211
MJB3S32B35	350mm	\$321	\$197	\$389	\$236

3齒
(中)

型號	實際尺寸	鍍鉻	黑胚	沙丁鏢	黑/白
MJB3S32C05	50mm	\$211	\$138	\$253	\$159
MJB3S32C10	100mm	\$231	\$148	\$286	\$177
MJB3S32C15	150mm	\$256	\$164	\$323	\$192
MJB3S32C20	200mm	\$279	\$177	\$346	\$200
MJB3S32C25	250mm	\$295	\$192	\$367	\$231
MJB3S32C30	300mm	\$346	\$212	\$393	\$239
MJB3S32C35	350mm	\$359	\$233	\$426	\$277



※附架手固定塞

施工範例

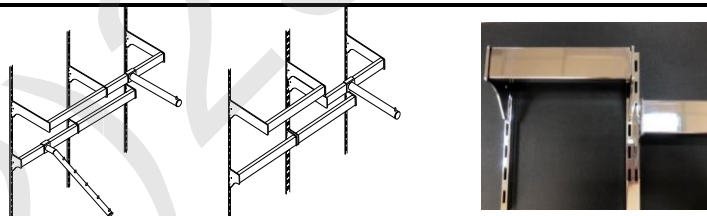

關聯配件 PARTS

角管掛桿



14*32mm角管,有各種長度/顏色,詳細請參閱型錄④-2

角管端頭用



1432角管用管塞



1432角管用管塞(有前檔)

掛桿 Hanger Pipe

圓管φ25、φ32

MJPH Series

KAWAJUN

圓管掛桿



φ25圓管

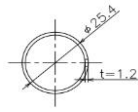

價格表 PRICE

型號	尺寸(mm)	鍍鉻	黑胚	黑/白
MJPH2506	600	\$157	\$89	\$165
MJPH2509	900	\$230	\$127	\$187
MJPH2512	1200	\$283	\$165	\$286
MJPH2515	1500	\$371	\$203	\$538
MJPH2518	1800	\$439	\$246	沒有

φ32圓管

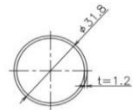

型號	尺寸(mm)	鍍鉻	黑胚	黑/白
MJPH3206	600	\$183	\$115	\$168
MJPH3209	900	\$268	\$156	\$230
MJPH3212	1200	\$394	\$200	\$304
MJPH3215	1500	\$457	\$260	\$610
MJPH3218	1800	\$620	\$307	沒有

施工範例

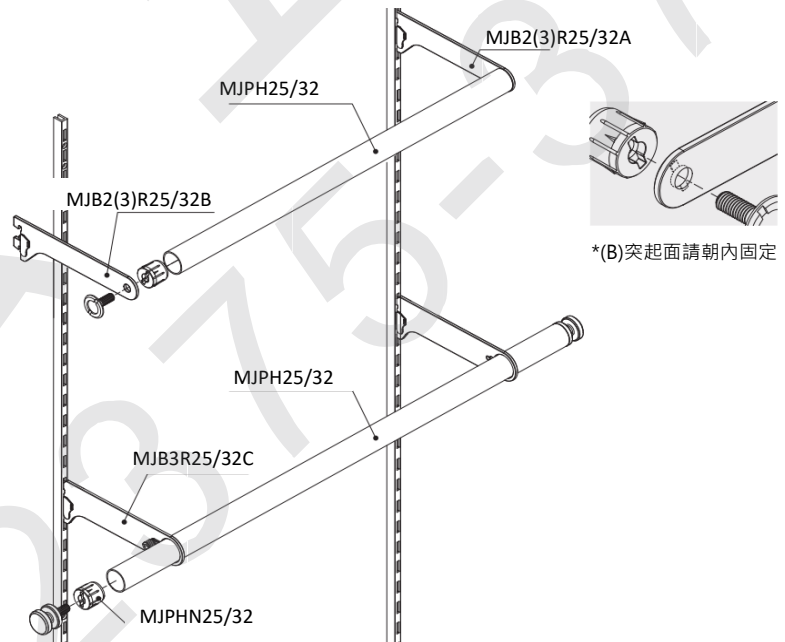

關聯配件 PARTS

圓管端頭用



圓管用內塞

	型號	鍍鉻
φ25用	MJPHN25	\$56
φ32用	MJPHN32	\$62



圓管用鎖配件

	型號	鍍鉻	沙丁鍊
φ25用	MJEC25	\$77	\$96
φ32用	MJEC32	\$102	\$120

掛桿 Hanger Pipe

角管14*32

MJPH Series

KAWAJUN

角管掛桿

價格表 PRICE

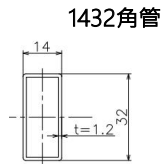
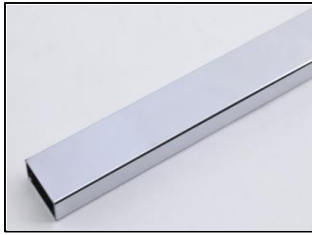

型號	尺寸(mm)	鍍鉻	黑胚	黑/白
MJPH143206	600	\$288	\$209	\$230
MJPH143209	900	\$395	\$290	\$310
MJPH143212	1200	\$539	\$413	\$450



施工範例

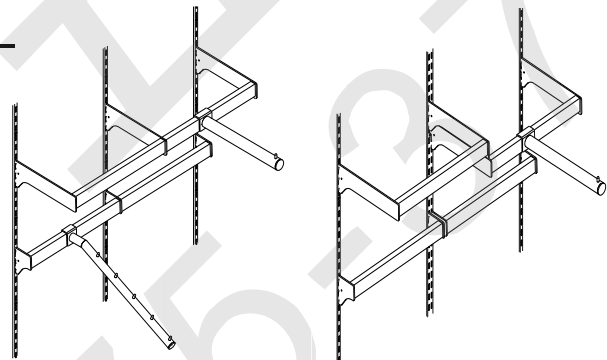

關聯配件 PARTS

方管端頭用



1432角管用管塞

型號	鍍鉻
MJES1432	\$61



1432角管用管塞(有前檔)

型號	鍍鉻
MJED1432	\$62

角管用架手



1432角管用架手,有多種規格(深度50~350mm)以及顏色,詳細請參閱型錄③-4

掛鉤1 Hanger

角管用掛鉤

MJH Series

KAWAJUN

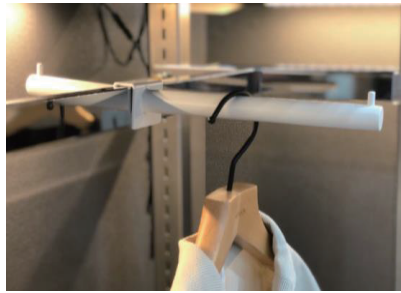

單Pin直掛鉤

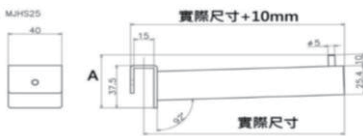

價格表 PRICE

管徑	型號	實際尺寸	鍍鉻	沙丁鏢	黑/白
φ19	MJHS1915	150mm	請另詢		
	MJHS1925	250mm			
	MJHS1930	300mm			
φ25	MJHS2515	150mm			
	MJHS2525	250mm			
	MJHS2530	300mm			

5Pin斜掛鉤

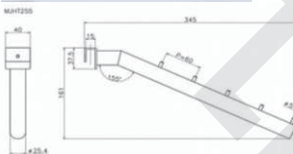

管徑	型號	實際尺寸	鍍鉻	沙丁鏢	黑/白
φ19	MJHT195	335mm	請另詢		
φ25	MJHT255	345mm			

雙邊用掛鉤

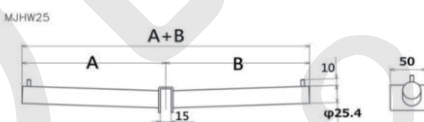

管徑	型號	A/B尺寸	鍍鉻	沙丁鏢	黑/白
φ19	MJHW192010	200/100	請另詢		
	MJHW192020	200/200			
	MJHW192515	250/150			
	MJHW192525	250/250			
	MJHW193030	300/300			
φ25	MJHW252010	200/100			
	MJHW252020	200/200			
	MJHW252515	250/150			
	MJHW252525	250/250			
	MJHW253030	300/300			

關聯配件 PARTS

角管掛桿



14*32角管,長度600,900,1200mm,並有各種顏色
詳細請參閱型錄④-2

角管用架手



1432角管用架手,有多種規格(深度50~350mm)及顏色,
詳細請參閱型錄③-4

部品配件 Parts

KAWAJUN

玻璃層板補強



裝置於玻璃層板下方，
可避免架手左右搖晃，
同時增加整體強度。

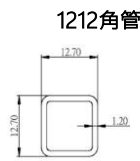

價格表 PRICE

型號	實際總長	鍍鉻	黑胚	沙丁鏢
MJPH1212596	596	\$164	\$107	\$186
MJPH1212896	896	\$231	\$143	\$266
MJPH12121200	1200	\$280	\$179	\$330

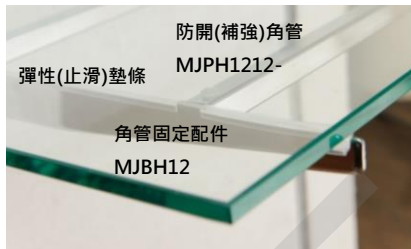

角管固定配件

型號	SUS430
MJBH12	\$11

彈性墊條

型號	透明EVA
MJOP002-100	\$1

(每100mm單價)

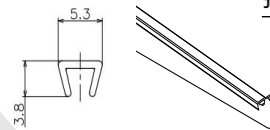

備註: 依照玻璃層板用架手深度搭配, 亦可指定購買長度另外單購。

架手相關



架手固定塞

型號	尼龍(黑)
MJOP001	\$7



安裝方式

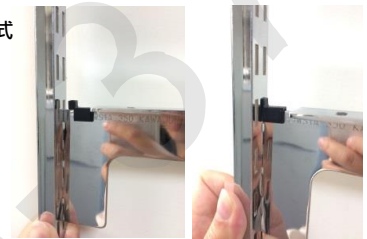

備註: 架手固定塞本價格為提供已購買架手顧客追加備用採購用, 且追加數量最多為該訂單所購買架手之數量。
未購買我司架手顧客零售價為 \$20元/個

圓管端頭用



圓管用內塞

	型號	鍍鉻
φ25用	MJPHN25	\$56
φ32用	MJPHN32	\$62



鎖頭φ25 x t2.5 鎖芯24mm
鎖頭φ32 x t2.5 鎖芯32.5mm

圓管用鎖配件

	型號	鍍鉻	沙丁鏢
φ25用	MJEC25	\$77	\$96
φ32用	MJEC32	\$102	\$120

方管端頭用



1432角管用管塞

型號	鍍鉻
MJES1432	\$61



1432角管用管塞(有前檔)

型號	鍍鉻
MJED1432	\$62



固定方式

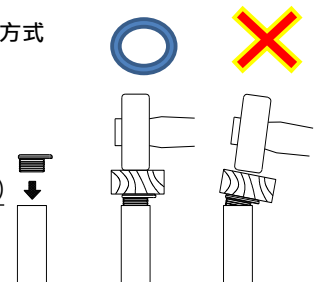

部品配件 Parts

KAWAJUN

暗樁/固定配件



黑色彈性橡膠圈具止滑功用。



價格表 PRICE

暗樁

型號	鍍鉻	黑色
MJDD12A	\$69	\$65

載重: 一個10kg,
使用四個(一片棚板) 總載重40kg

另有金色款/售完即止(請洽業務人員)

安裝方式

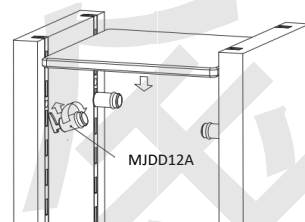

由下往上插入排孔內,順時針方向轉緊固定。
四個暗樁固定於相同高度即可擺放層板。

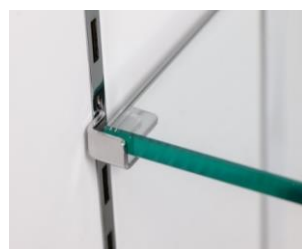

附透明止滑貼。



玻璃固定配件

型號	鍍鉻
MJDG01	\$41
MJDG02	\$41

右
左

載重: 一個10kg, 使用四個(一片棚板) 總載重40kg

另有金色款/售完即止(請洽業務人員)

安裝方式



配件有分左右,由下往上插入排孔內,一層搭配左2右2,共4個。

內側掛桿固定配件



Davo pipe stay

型號	鍍鉻	黑胚
MJDS275	\$186	\$106

注意 此為單支品號

載重: 兩支一組40KG

安裝方式



固定於MJDD12A 暗樁上



特殊設計、裝卸容易

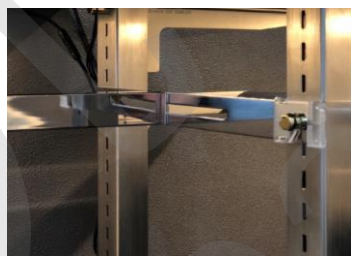

方管內塞



型號	鍍鉻	黑胚
MJPHN1432	\$50	\$42

MJDS275搭配方管時的固定內塞

固定扣安裝方式



將固定扣的公頭穿過架手上



於板材上的對應位置上開洞，
並與固定扣相組合。
建議開孔尺寸φ10 x 深12mm



完成!

木層板固定扣



樹脂固定扣

型號	單價
MJOP011	\$8

※優勢特色 無需電鑽工具和
釘子即可輕鬆裝卸木層板

LED系列

磁吸式LED



主體: 鋁+乳白PC罩
 輸入電壓: DC12/24V
 光源類型: SMD2835
 發光角度: 120°
 顯色指數: >80
 光效: ≥70lm/W
 工作溫度: -20~+50°C
 使用壽命: 30000hrs

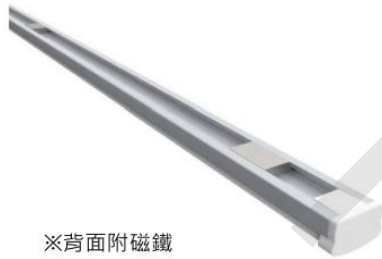

價格表 PRICE

型號	長度mm	色溫	白(HT)/黑(KB)
TUB525	550	3000K	\$358
TUB529	850	3000K	\$528
TUB532	1150	3000K	\$660
TUB806	550	6500K	\$358
TUB811	850	6500K	\$528
TUB814	1150	6500K	\$660

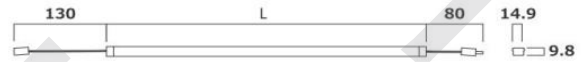

LED可顯色溫的區別:



LED用配件



木板用固定卡扣

型號	不鏽鋼
TUB533	\$10



旋卡接頭(電源連接線)

型號	接頭類型	白(HT)/黑(KB)
TUB523	公頭	\$132 (接LED)
TUB838	母頭	\$182 (接變壓器)

迷你導電軌



※背面附磁鐵

輸入電壓: DC12V/24V
 輸出電壓: DC12V/24V



型號	長度mm	顏色	價格
TUB522HT	1000	白	\$356
TUB842HT	1500	白	\$538
TUB522KB	1000	黑	\$356
TUB676KB	1500	黑	\$538

產品特色:

- 迷你尺寸,厚度僅5.7mm。
- 搭配旋卡連接線即可供電。
- 採用上層紫銅線,導電性強大,免維護。
- 搭配經典黑白兩色,更加凸顯高端大氣。

- 以上為現貨款式,其他長度請另詢問相關業務
- 另售有變壓器(90W/120W)

重柱差異&附贈配件

重柱D系列與S系列差異



重柱D系列



重柱S系列

重柱D (左圖)
 兩邊高出3.75mm 可避免架手左右搖晃
 並隱藏架手掛齒及重柱排孔。
 *無法使用架手固定塞
 *需搭配專用螺絲以及十字起子頭

重柱S (右圖)
 架手掛齒及重柱排孔較明顯。
 可加裝架手固定塞(防止架手掉落)



架手附贈配件

凡購買KAWAJUN架手即附贈架手固定塞*1

敝司的架手固定方式是使用黑色塑膠固定塞,
 有別於傳統防脫螺絲,更美觀且容易安裝,也不會有防脫螺絲生鏽無法拆卸之問題。

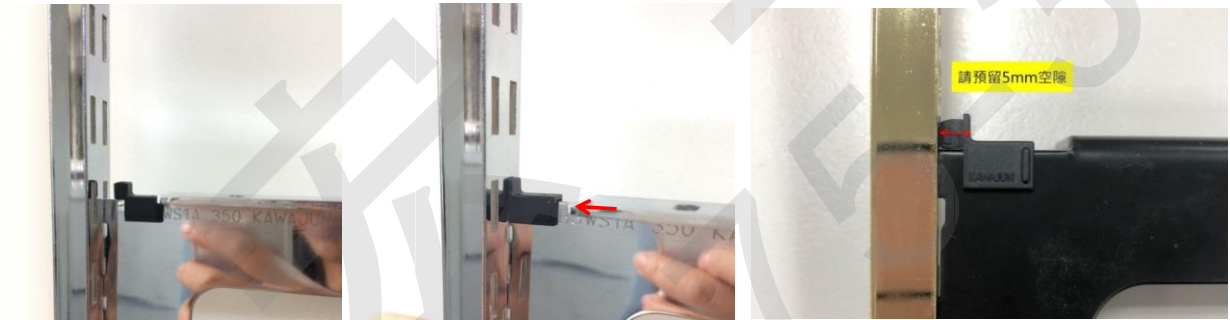

搭配木層板時,木層板與重柱間距離,
 建議預留架手固定塞之鬆脫範圍5mm(以上)
 則無須卸下螺絲即可移動將整組層板。

玻璃架手再加贈止滑條(依架手長度配)

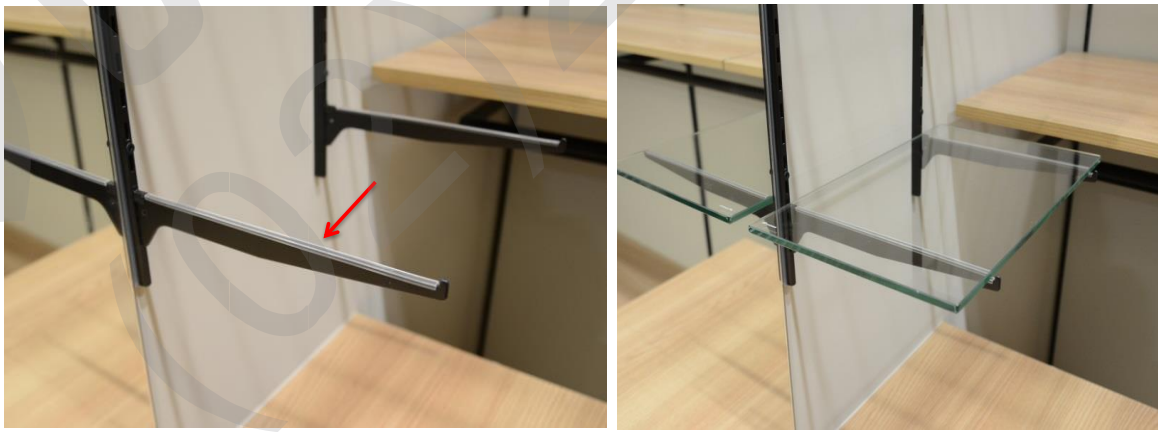

螺絲規格單價&排孔管安裝

KAWAJUN

螺絲規格與單價

我司MJRS11/MJRS14/MJRW11/MJRW14
適用螺絲尺寸規格如下圖



我司也有販售專用木螺絲，一包50支

品號	品名	材質	單價/包
MJNB0320-S	皿頭螺絲φ6*20mm (50入)	鍍鋅	\$30
MJNB0325-S	皿頭螺絲φ6*25mm (50入)	鍍鋅	\$35
MJNB0330-S	皿頭螺絲φ6*30mm (50入)	鍍鋅	\$40
MJNB0325K-S	皿頭螺絲φ6*25mm (50入)	鍍黑	\$70
MJNB0330K-S	皿頭螺絲φ6*30mm (50入)	鍍黑	\$80

重柱螺絲數量計算 (單排與雙排孔數相同)

重柱長度	螺絲孔數
600	4
900	5
1200	7
1500	8
1800	9
2400	12
3000	15

搭配S11重柱 (深度1.1cm)

- 20mm 扣掉重柱深度 約有0.9cm 突出(鎖在後方)
- 25mm 扣掉重柱深度 約有1.4cm 突出(鎖在後方)
- 30mm 扣掉重柱深度 約有1.9cm 突出(鎖在後方)

搭配S14重柱 (深度1.4cm)

- 20mm 扣掉重柱深度 約有0.6cm 突出(鎖在後方)
- 25mm 扣掉重柱深度 約有1.1cm 突出(鎖在後方)
- 30mm 扣掉重柱深度 約有1.6cm 突出(鎖在後方)

太短不建議

排孔管安裝方式



調整腳輔助座 (頂天)

調整腳 (立地)

施工範例

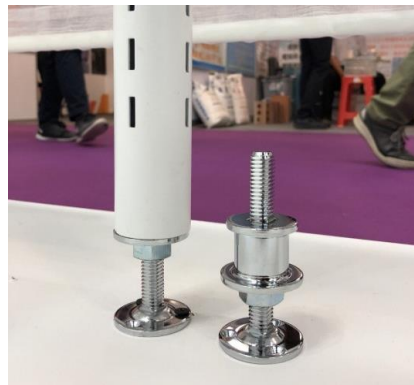
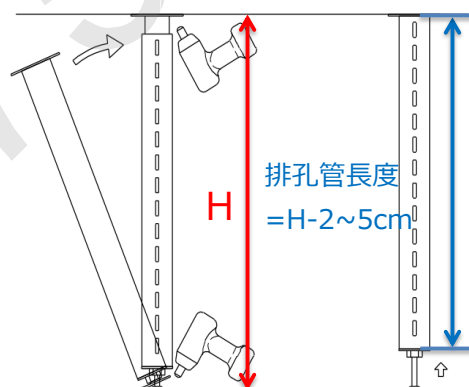

配件尺寸計算

掛桿長度計算

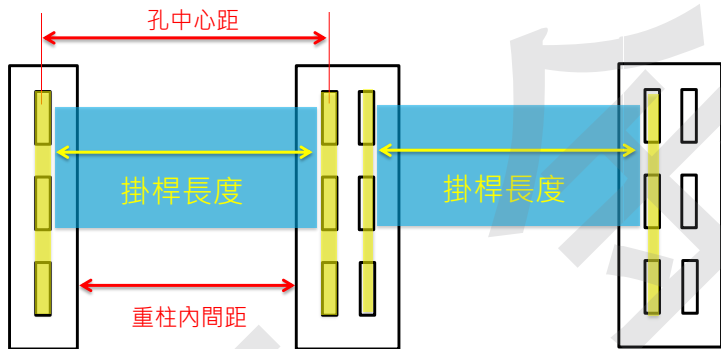
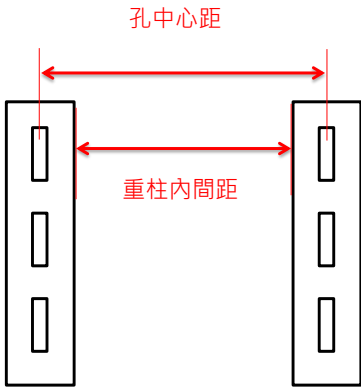

測量孔中心距方式(對齊孔邊緣)

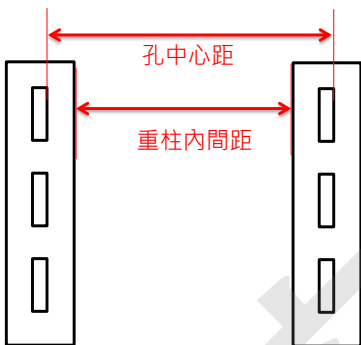

掛桿長度算法1 = 孔中心距 - 5mm (排孔管/重柱)
 掛桿長度算法2 = 重柱間距 + 2mm (單排雙排重柱)

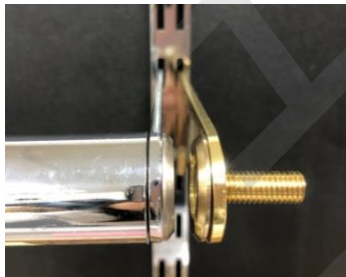

★使用圓掛桿時
 雙排重柱圓管端頭鎖
 請選用MJEC款式

玻璃層板尺寸計算(MJDG)

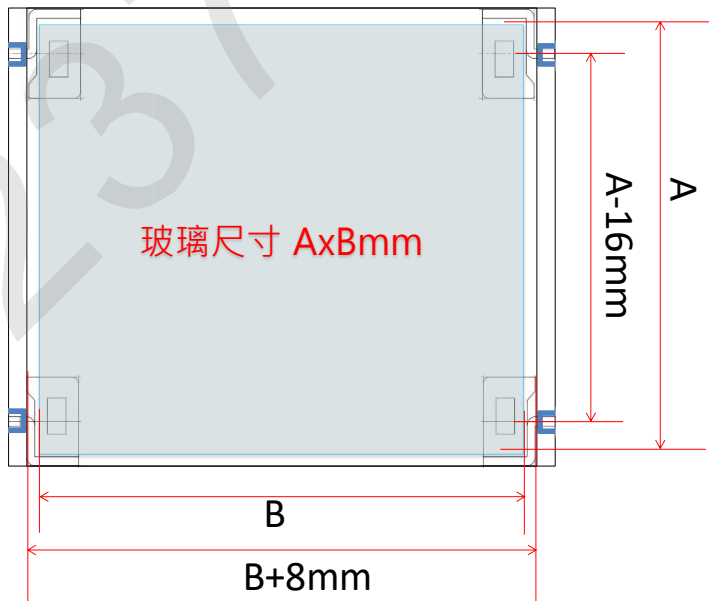

型號	品名
MJDG01C	玻璃固定件(右)鍍鉻
MJDG02C	玻璃固定件(左)鍍鉻

載重: 一個10kg, 使用四個(一片棚板) 總載重40kg