

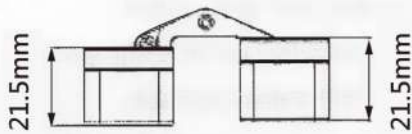

三維可調隱形鉸鍊/3D Adjustable Concealed Hinge 150X25mm 鋅合金/Zinc Alloy

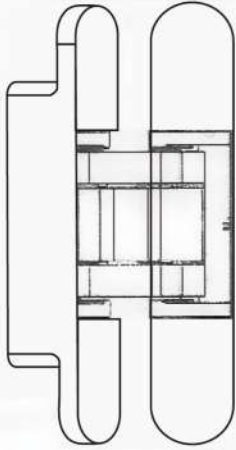

四軸加厚支撐臂



四軸支撐

受力均勻

三維調節

開合靜音

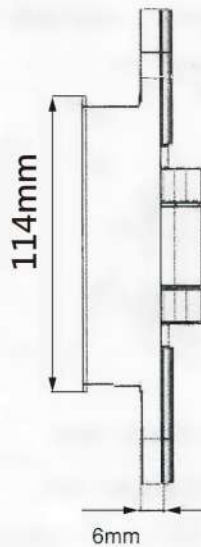
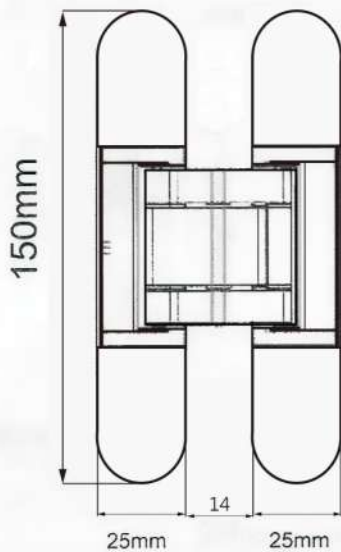

- | | |
|------------------------------|---|
| • 最大承重/Max door weight : | 40kg (2支暗鉸鍊承重/bearing weight of 2 hinges) |
| • 開啟角度/Max opening angle : | ≤180° |
| • 門寬/Max door width : | ≤850mm |
| • 門高/Max door height : | ≤2286mm |
| • 門板厚度/Min door thickness : | ≥35mm |
| • 調節性能/Adjustment function : | 三維可調 上下+3.0mm,前後+1.0mm,左右+2.0mm |



包裝內含/Package:2支暗鉸鍊/2hinges,螺絲工具包/accessory screws&tools,說明書/Instruction



安裝說明書 / Installation instructions

1

按照下圖所示在門扇和門框上開槽/Make a slot on door leaf and door frame as the picture shown.

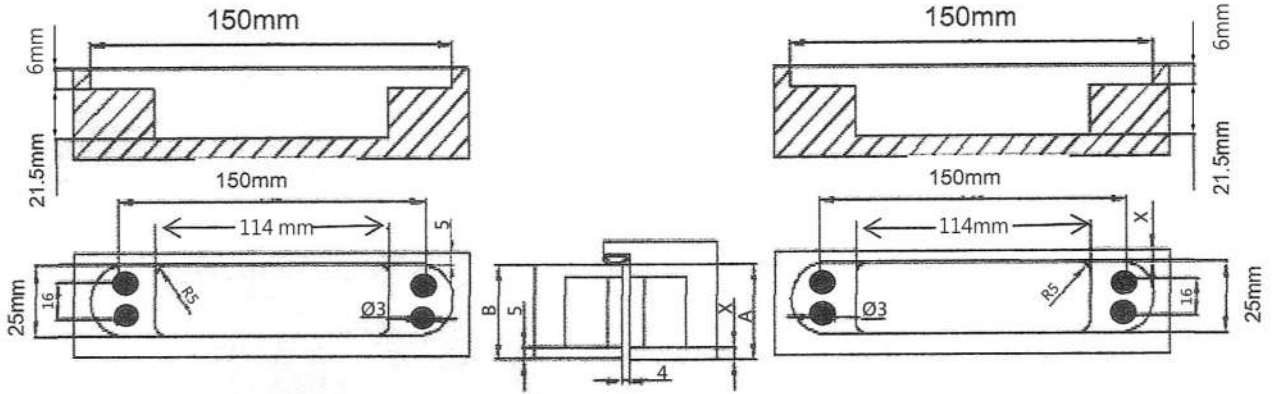

門扇與門框開孔尺寸/ Hole dimension of door leaf & door frame

A=密封條到門框邊的深度/ The depth between seal and door frame

B=門扇厚度/ The thickness of door leaf

A-B+5=測量X值 (X值規定範圍為 5~8 mm/ X range is 5~8 mm)

步驟1: 如圖①將標有“Door”字樣邊裝於門扇所開孔內，使用十字螺絲刀將產品收入門扇內；

Step 1: As the picture ①, use cross screwdriver to install the hinge into door leaf hole with screws.

步驟2: 如圖②將裝好產品的門扇對應位置裝於已开好孔的門框內，並用十字螺絲刀進行旋緊。

Step 2: As the picture ②, use cross screwdriver to install the door leaf with hinge into door frame hole with screws.

步驟3 安裝並調試完成後，保證合頁安裝牢固可靠，合頁表面合門框、門扇側面平齊。

Step 3: Overall check to ensure that all parts are installed tightly after installment and adjustment.

2

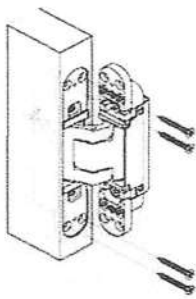

①先安裝門上

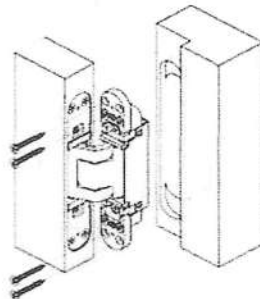

②再安裝門框側

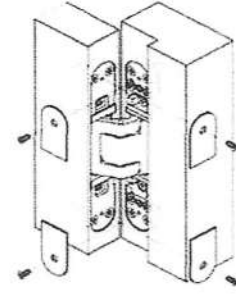

③調節好後裝上裝飾蓋

步驟4: 反覆操作門扇開啟合閉多次，檢查一切正常交客戶使用。

Step 4: Open and close for several times to check that it work safely and smoothly.

3

調節示意/ Adjustment: 上下/Up&Down:13.0mm · 前後/In&Out:t1.0mm · 左右/Left&Right:t2.0mm

